

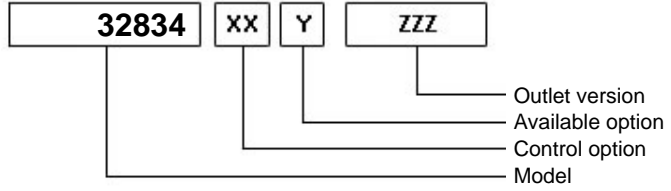

PZB®

D01P-0-03 - Pagina WebPTO PZB - rev. 0

32834

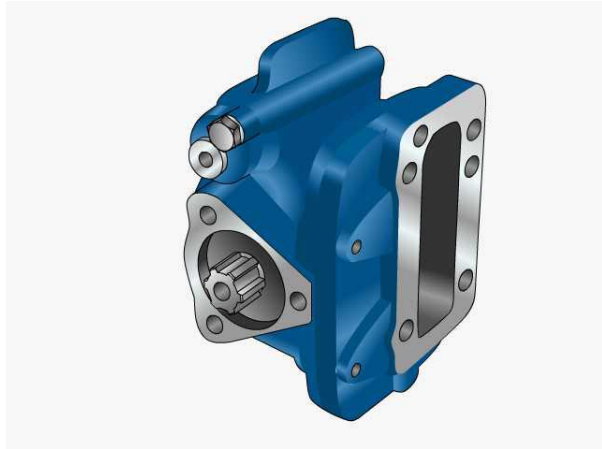

	Output 1		Number of teeth	19
Torque (Nm)	250		Module	4
Int. ratio	1		Replace	
Number of axles	1		Replaced by	

06/09/2006

Command type

- Mechanical with lever remote control (TC)
- Ready for electric solenoid control
- Mechanical with PUSH-PULL remote control
- Hydraulic control
- Depressure control
- Electric control KES 5
- Pneumatic
- Constantly engaged
- Ready for detached control

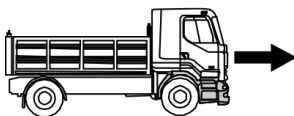
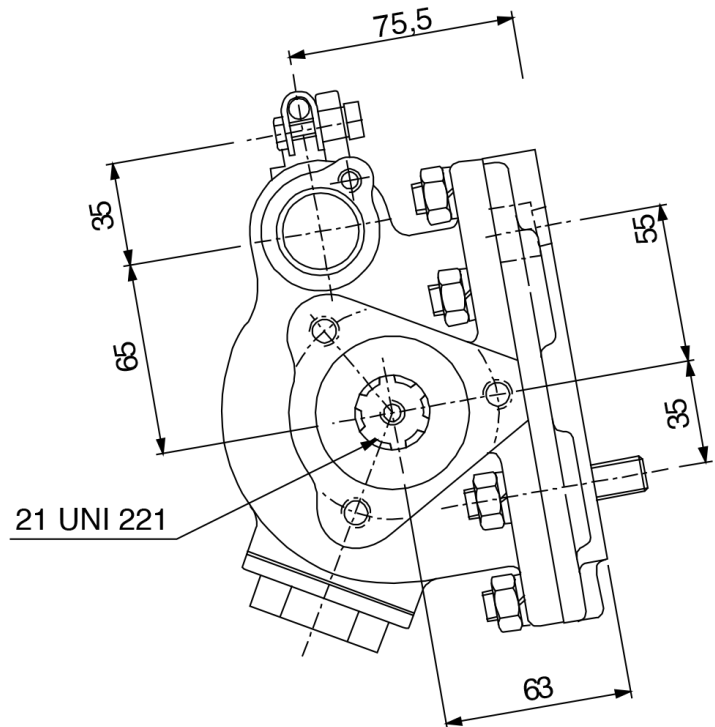
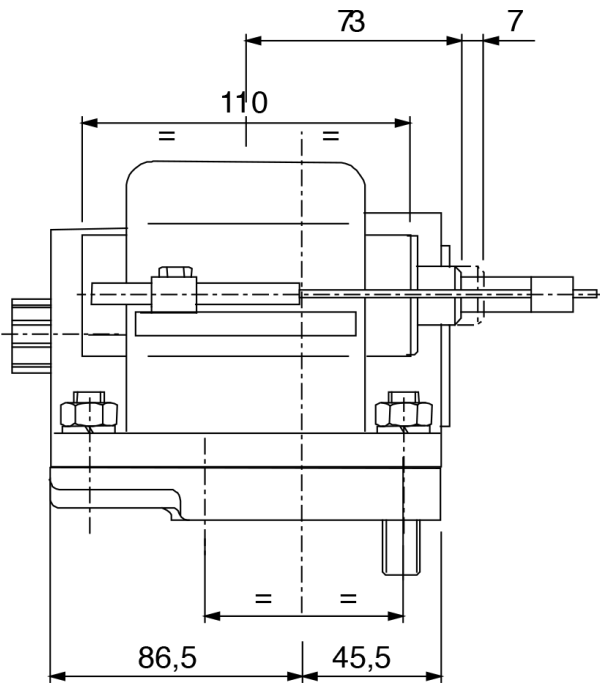

Interpump Hydraulics Spa a socio unico - **Business Unit PZB**

Sede Legale: via A. Mingozzi, 6 • 40012 Calderara di Reno BO - Italy

Sede Operativa: via A. Mingozzi, 6 • 40012 Calderara di Reno BO - Italy • T +39 051 6460511 • F +39 051 6460560 • info@pzbitaly.com • pzbitaly.com

Cap. Soc. Euro 2.631.600,00 i.v. • N. Mecc. BO 056383 • R.E.A. BO 444225 • C.F. 00883010241 • P.Iva IT02128140361

Soggetta ad attività di Direzione e Coordinamento da parte di Interpump Group Spa

